

PRO SWING OA-EDGE T

5916332 FEB 2013

NM-0001-5

Original instructions

MANUFACTURER'S STATEMENT

Read this operation manual carefully before use to ensure proper operation of this product. Failure to read this operation manual may cause improper operation and may result in serious injury or death of a person. The meanings of the symbols are as follows. Please study the following first and then read the contents of this operation manual.

	WARNING Disregard of warning may cause improper operation causing death or serious injury of a person.
	CAUTION Disregard of caution may cause improper operation causing injury of a person or damage to objects.
	NOTE Special attention is required to the section of this symbol.
	It is required to check the operation manual if this symbol is shown on the product.
	Setting to meet the requirements by EN16005.

- NOTE**
- This sensor is a non-contact switch intended for door mounting and to use on automatic swing doors.
 - When setting the sensor's detection area, make sure that there is no traffic around the installation site.
 - Before turning the power ON, check the wiring to prevent damage or malfunction of equipment connected to the sensor.
 - Only use the sensor as specified in the operation manual provided.
 - Be sure to install and adjust the sensor in accordance with the local laws and standards of the country in which the sensor is installed.
 - Before leaving the installation site make sure that the sensor is operating properly and instruct the building owner/operator on proper operation of the door and the sensor.
 - The sensor settings can only be changed by an installer or service engineer. When changed, the changed settings and the date shall be registered in the maintenance logbook accompanying the door.

	WARNING Do not wash, disassemble, rebuild or repair the sensor otherwise it may cause electric shock or breakdown of the equipment.
Danger of electric shock	

- NOTE** The following conditions are not suitable for sensor installation :
- Fog or exhaust emission around the door.
 - Moving objects or objects that emit light near the detection area.
 - Highly reflecting floor or highly reflecting objects around the door.
 - Wet floor.
 - Grating floor.

SPECIFICATION

Model	: OA-EDGE T	Noise level	: <70dBA
Profile color	: Silver / Black	Output hold time	: Approx. 0.5 sec.
Mounting height	: 1.5 (4'11") to 3.0m (9'10")	Response time	: <75msec.
Detection area	: See DETECTION AREA	Operating temperature	: -20 to +55°C (-4 to 131°F)
Detection method	: Triangulation	Operating humidity	: <80%
Min. configuration	: 1 master module +1 LED module	IP rate	: IP54
Max. configuration	: 4 sensor modules +2 LED modules	Category	: 2 (EN ISO13849-1 : 2008)
Depth angle adjustment	: 0° to +25°	Performance level	: d (EN ISO13849-1 : 2008)
Power supply *	: 12 to 24VAC ±10% (50 / 60 Hz) 12 to 30VDC ±10%		
Power consumption	: < 1.3W (< 2VA at AC) at Min. configuration < 3.5W (< 4.5VA at AC) at Max. configuration		
LED indicator	: See chart below		
Test input	: Opto coupler 10 to 30VDC Current / 6mA Max.		
Safety / Test output 1	: Form C relay		
Safety / Test output 2	: Voltage / 42VDC Current / 0.3A Max (Resistance load) Output : see INSTALLATION chapter 3. Wiring		

* : The sensor has to be connected to a door system is equipped with a SELV circuit. The overcurrent protection of power supply cable has to be less than 2A.

EN16005 Install the sensor at 1.8m (5'11") to 2.5m (8'2").

LED indicator

Status	Sensor module indicator	LED module indicator
Stand-by	Solid Green	The color depends on the state of the output.
Opening side detection (output 1)	Solid Red	Safety / Test output 1 OFF : Solid Green
Closing side detection (output 2)	Solid Orange	ON : Solid Red
Incomplete Initialization	Red & Green blinking	Safety / Test output 2 OFF : Solid Green
Learning	Blinking Yellow	ON : Solid Orange
Incomplete learning	Yellow & Red blinking	
Saturation	Slow Red blinking	
Sensor failure	Fast Red blinking	
Communication error	Twice Orange blinking	

NOTE The specifications herein are subject to change without prior notice due to improvements.

OUTER DIMENSIONS AND PART NAMES

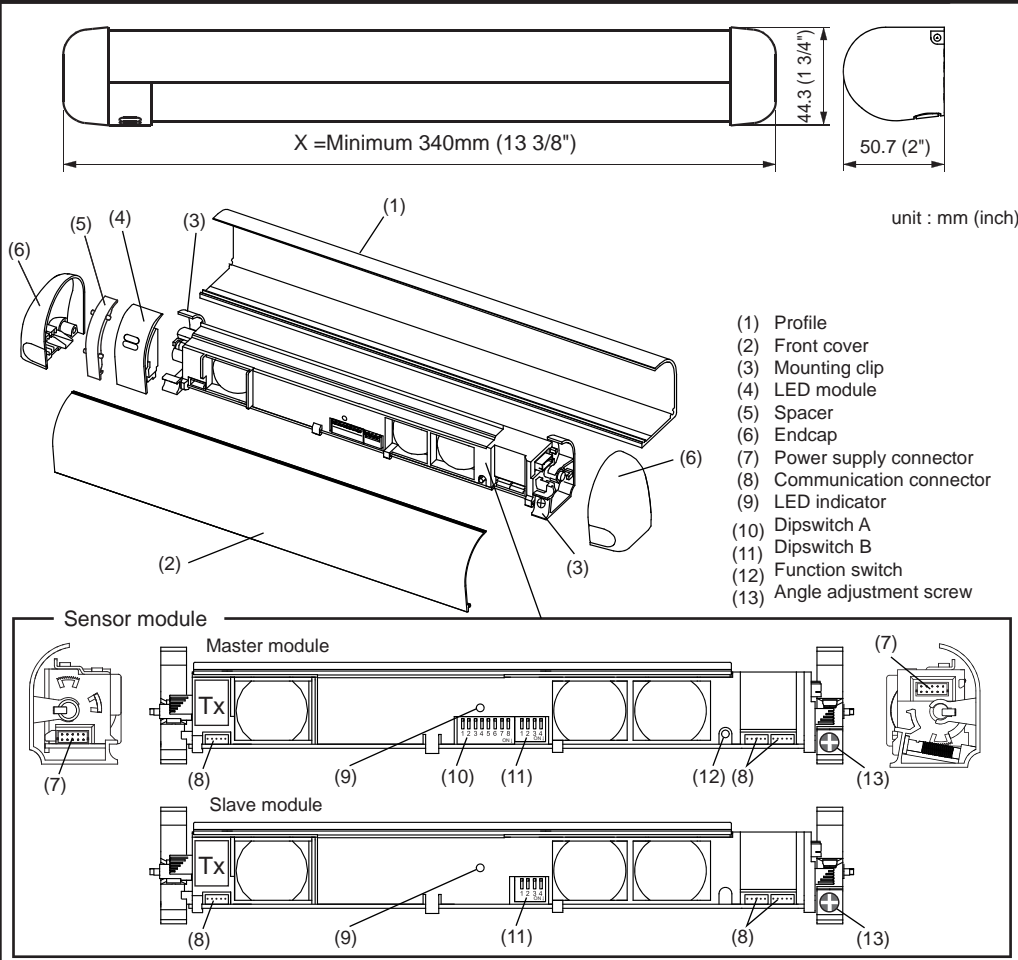

COMPLIED STANDARDS

EN 16005:2012 EN 12978:2003 +A1:2009 Machinery Directive 2006/42/EC
 EMC Directive 2004/108/EC EN ISO 13849-1:2008 EN ISO 13849-2:2008
 EN 61496-3:2001 clause 4. 3. 5 and 5. 4. 7. 3
 Notified Body : TÜV NORD CERT GmbH Langemarckstr. 20 45141 Essen Germany
 EC-type examination certificate No. 44 205 13 417493-002

DETECTION AREA

Detection area at 2200mm (7' 2 5/8") : Depth 140 (5 1/2") x Width 870 (2'10")

Test conditions required by EN 16005 Detection object : EN 16005 CA reference body

Emitting area at 2200mm (7' 2 5/8") : Depth 140 (5 1/2") X Width 440 (1' 5 1/2")

NOTE The actual detection area may become smaller depending on the ambient light, the color / material of the object or the floor as well as the entry speed of the object.

Recommended installation position

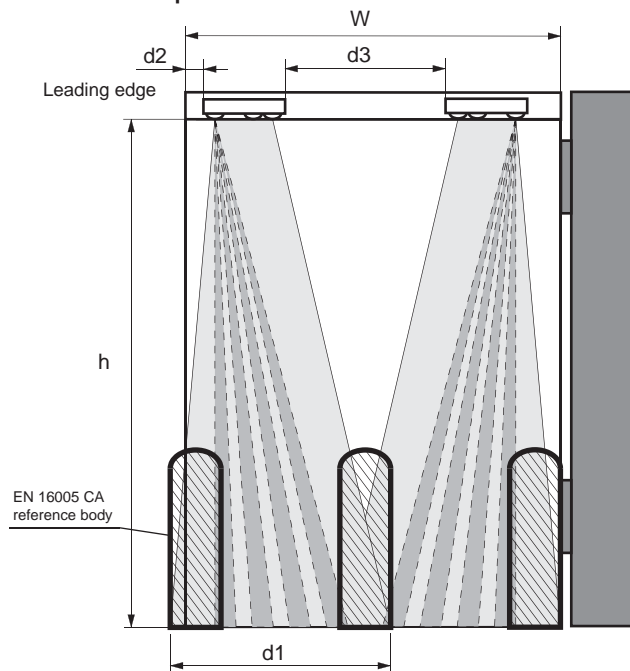

W = Door width
 h = Mounting height
 d1 = Detection area width
 d2 = Distance from the leading edge to the sensor module
 d3 = Distance between sensor modules
 n = Number of sensor modules
 unit : mm (inch)

h	W		900 (2'12")		1100 (3'7")		1200 (3'11")	
	d1	d2	n	d3	n	d3	n	d3
1900 (6'3")	760 (2'6")	70 (2 3/4")	2	175 (6 7/8")	2	375 (14 3/4")	2	475 (18 5/8")
2000 (6'7")	790 (2'7")	70 (2 3/4")	2	160 (6 3/8")	2	355 (14")	2	460 (18 1/8")
2100 (6'11")	825 (2'9")	70 (2 3/4")	2	145 (5 6/8")	2	345 (13 5/8")	2	445 (17 1/2")
2200 (7'3")	870 (2'10")	70 (2 3/4")	2	125 (5")	2	320 (12 5/8")	2	420 (16 4/8")
2300 (7'7")	895 (2'11")	70 (2 3/4")	2	115 (4 1/2")	2	315 (12 3/8")	2	415 (16 2/8")
2400 (7'11")	920 (3")	70 (2 3/4")	2	110 (4 1/2")	2	310 (12 2/8")	2	410 (16 1/8")
2500 (8'2")	950 (3'1")	70 (2 3/4")	2	110 (4 3/8")	2	300 (11 6/8")	2	400 (15 3/4")

NOTE For installation heights <1900mm the installation of an extra module will be mandatory in order to comply with the regulations.

INSTALLATION

1 Mounting the profile

- Take the sensor modules out of the profile.
- If the profile is longer than the door width, cut the profile. Make sure not to scratch the front cover.
- Affix the profile on the intended mounting position leaving more than 20mm (13/16") from door edge to attach the endcap.
- If necessary, drill two mounting holes of $\phi 3.4\text{mm}$ ($\phi 1/8"$) and fix the profile.
- When mounting a sensor on each side of the door, it is necessary to drill a wiring hole of $\phi 12\text{mm}$ ($\phi 1/2"$) to connect the sensor modules. (See chapter 3. Wiring)

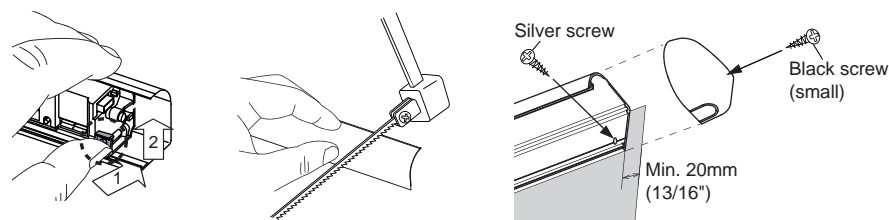

NOTE Make sure there is some space between the mounting clips and the mounting screws. Make sure not to scratch the profile when making a hole.

2 Inserting the sensor module

The lens that is marked "Tx" must be positioned onto the corresponding door edge. Refer to **DETECTION AREA** for the sensor module position. The sensor module can be inserted in reverse as shown below. To do this, detach the mounting clip and rotate the sensor module by 180° and reattach the mounting clips.

NOTE Make sure to fix the sensor modules firmly by the mounting clips.

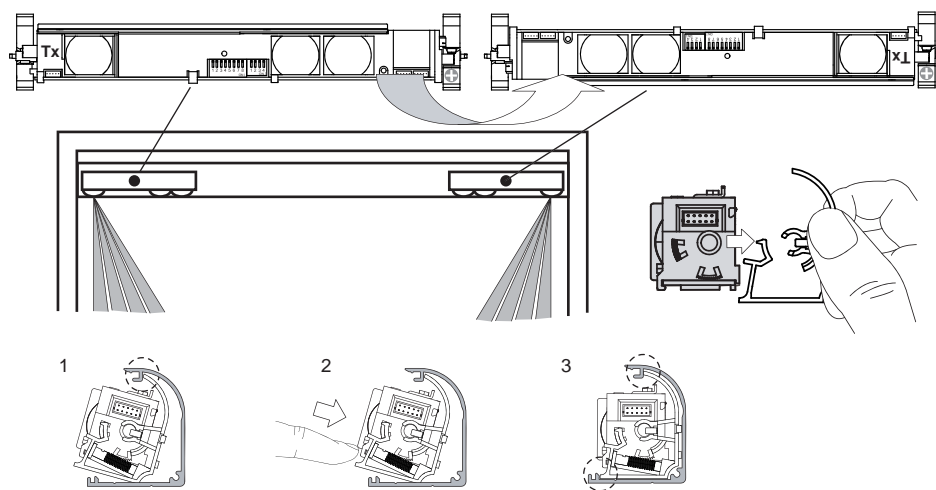

INSTALLATION

3 Wiring

Wired the cable to the door controller as shown below.

Power supply cable Communication cable

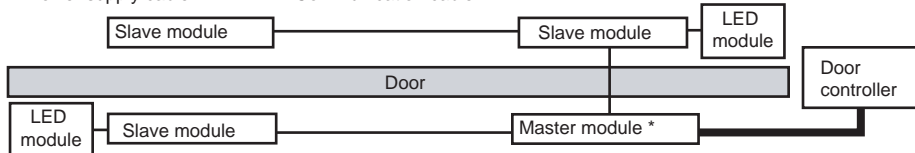

NOTE * When more than 1 master module is installed on the door leaf, make sure that only one power supply cable is connected to the operator otherwise initialization can not be completed. All other master units will automatically function as a slave unit.

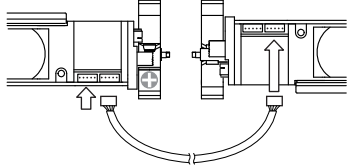

Each module has three communication connectors. Use the most convenient connector for the installation site.

NOTE Maximum of three sensor modules can be connected to one master module.

To the power supply connector of the master module

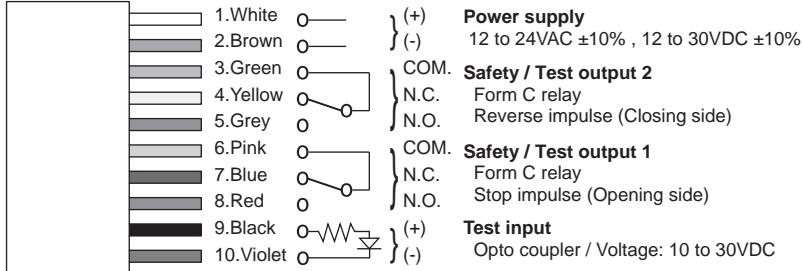

NOTE When a test input is not required, set the dipswitch A7 to OFF.

WARNING

Danger of electric shock

Before starting the procedure, make sure that the power is turned OFF. When passing the cable through the hole, do not tear the shield otherwise it may cause electric shock or breakdown of the sensor.

4 Inserting LED module

Connect the communication cable of the LED module to the master or slave module. Attach the spacer on the endcap side. Insert the LED module to the profile as shown below. The LED module can be inserted to both side of the profile.

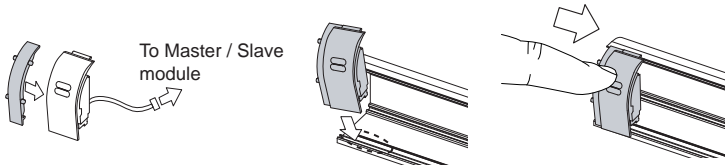

NOTE For LED status see SPECIFICATION

5 Placing the front cover

After **ADJUSTMENTS** are completed, place the front cover and endcaps.

ADJUSTMENTS

1 Dipswitch settings

Each Master module is equipped with Dipswitch A and Dipswitch B and each Slave module is equipped with only Dipswitch B. Only dipswitch A of the master module connected to the door controller is applicable and will reflect the settings to all connected master and slave units automatically.

Dipswitch A	A1	A2	A3	A4	A5	A6	A7	A8
1	Non detection zone (A)	Frequency	Immunity	Presence timer	For future use		Test input	Test input delay

Dipswitch B	B1	B2	B3	B4
1	Non detection zone (B)	Area width	Self monitoring	Mounting side (Output select)

NOTE Only correctly initialising the sensor ensures the correct functioning of the dipswitches (see chapter 2. Function switch)

1-1. Setting the non detection zone

The non detection zone is the height measured from the floor up to the position where the sensor starts to detect. The zone can be set by a combination with Dipswitch A1 & B1.
[Non detection zone value] = [Dipswitch A1 value] + [Dipswitch B1 value]

Side view	Dipswitch A1	Dipswitch B1	Non detection zone
	OFF : "15cm"	OFF : "+0cm"	15cm (5 7/8")
	OFF : "15cm"	ON : "+10cm"	25cm (9 13/16")
	ON : "35cm"	OFF : "+0cm"	35cm (13 3/4")
	ON : "35cm"	ON : "+10cm"	45cm (17 11/16")

NOTE The value is a reference for a mounting height of 1.8 to 2.5m (5' 11" to 8' 2").

1-2. Setting the frequency

When installing the sensors on a double swing door make sure that the frequency on each sensor is set differently.

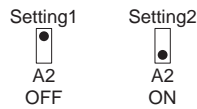

1-3. Setting the immunity

Set Dipswitch A3 to ON when the sensor operates by itself (ghosting).

NOTE When Dipswitch A3 is set to ON, the actual detection area may become smaller than Immunity off.

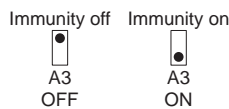

1-4. Setting the presence timer

The presence timer can be set by Dipswitch A4.

NOTE If an object remains in the detection area longer than the setting, LED indicator may blink fast Red. In this case, it is not Sensor failure. After an object is removed, LED indicator will show solid Green.

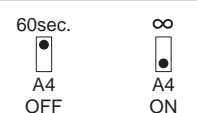

1-5. Setting the test input and test input delay time

Set dipswitches A7 & A8 according to the instructions from the door controller.

Test input and Safety / Test output timing chart

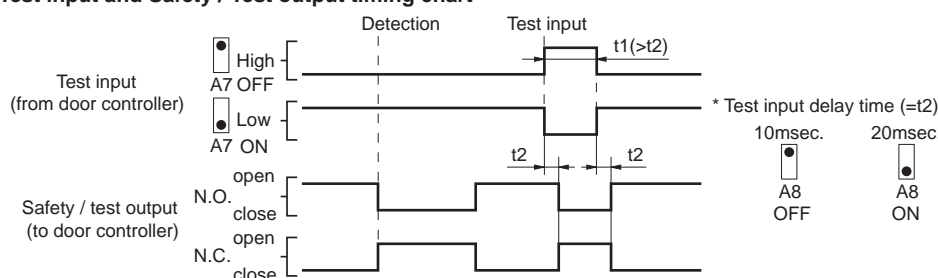

* The test input delay time is the time period between the test input and Safety / Test output.

1-6. Setting the area width

Set dipswitch B2 to "2 spots" when a narrow detection area is required.

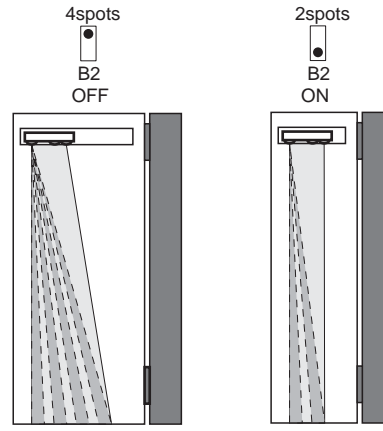

1-7. Setting the self monitoring

When the door remains open or closed, please refer to the **TROUBLESHOOTING** section. If the door still remains open or closed, set dipswitch B3 to "Disable"

EN16005

Set Dipswitch B3 to "Enable".

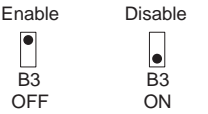

1-8. Setting the mounting side (output select)

By selecting the sensor position the outputs & LED indicator will function as shown below :

Dipswitch B4	Output	LED indicator
OFF : "Opening side (output 1)"	Safety / Test output1 (stop impulse)	Solid Red (detection)
ON : "Closing side (output 2)"	Safety / Test output2 (reverse impulse)	Solid Orange (detection)

2 Function switch

Only the master module is equipped with a function switch. The function switch of the master module that is connected to the door controller is only applicable to reflect settings to all sensor modules connected.

NOTE Make sure to use the function switch when the door is in the fully closed position.

2-1. Initialization

After a dipswitch setting change or when the power is supplied for the first time, the LED blinks red & green. Push the function switch for more than 2 sec. and then the LED indicator on the master unit will switch off. The LED indicator will start to blink green to indicate the number of connected sensor modules. The LED indicator will start to blink yellow and red and the initialization is completed. The LED is now indicating that you have to proceed a learning cycle.

2-2. Learning

Push the function switch for less than 2 sec. and then the LED indicator will start to blink yellow. The sensor will learn the non detection zone.

NOTE Do not enter the detection area when the sensor is performing a learning cycle. When the initialization and the learning cycle is completed, the sensor will be in stand-by mode and the LED will show solid green.

3 Area depth angle adjustment

The angle of each sensor module must be adjusted so that the door stops before it comes into contact with an obstacle. After area angle adjustments, start the learning as described in **chapter 2. Function switch**.

EN16005 After the adjustment, check the detection area.

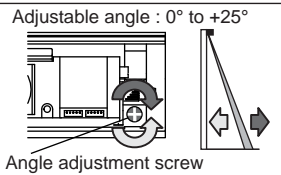

CHECKING

Check the operation according to the chart below.

NOTE The door movement might become unstable right after the learning. The movement becomes stabilized after several openings and closings. Always walk-test the detection area to ensure the proper operation.

Entry	Power OFF	Outside of detection area	Entry into opening side detection area	Entry into closing side detection area
Status	-	Stand-by	Detection active	Detection active
LED indicator	None	Solid Green	Solid Red	Solid Orange
Safety / Test output1 (Stop impulse)	COM. N.O. N.C.	COM. N.O. N.C.	COM. N.O. N.C.	COM. N.O. N.C.
Safety / Test output2 (Reverse impulse)	COM. N.O. N.C.	COM. N.O. N.C.	COM. N.O. N.C.	COM. N.O. N.C.

INFORM BUILDING OWNER / OPERATOR OF THE FOLLOWING ITEMS

WARNING

- Always keep the front cover clean. If dirty, wipe it with a damp cloth. (Do not use any cleaner / solvent.)
- Do not wash the sensor with water.
- Do not disassemble, rebuild or repair the sensor yourself, otherwise electric shock may occur.
- When LED indicator blinks Fast Red without any object in the detection area, contact your installer or service engineer.
- Always contact your installer or service engineer when changing the settings.
- Do not paint the front cover.

NOTE 1. After applying power, wait 10 seconds then walk test detection area to ensure proper operation. 2. Do not place any objects that move or emit light in the detection area. (e.g. Plant, illumination, etc.)

TROUBLESHOOTING

Problem	Possible cause	Possible countermeasures
The sensor has no function	Wrong power supply voltage Wrong wiring or connection failure	Set to the stated voltage. Check the wiring and connectors.
Incomplete initialization (Red & Green blinking)	Initialization has not been conducted. Dipswitch setting is changed.	Push the function switch for more than 2 sec. for initialization.
Initialization is not finished (Red & Green blinking continuous)	More than 2 master modules are connected with power supply wire.	Connect the power supply cable to only one master module.
Incomplete learning (Yellow & Red blinking)	Initialization has not been conducted.	Push the function switch for less than 2 sec. for learning.
Learning does not start (Twice Orange blinking)	Communication error	Check the communication wires or change wires.
Sensor operates by itself. (Ghosting) or learning is not finished. (Yellow & Red blinking continuous)	Objects that move or emit light in the detection area. (Ex.Plant, illumination, etc.) Same frequency setting on double swing door application. The modules are affecting each other. Signal saturation. The floor pattern is not plain or, the door movement is irregular.	Remove the objects. Set the different frequencies. (Dipswitch A2) Change the module positions or adjust angles or adjust the area width (Dipswitch B2). Set the immunity (Dipswitch A3) to "ON". Extend the non detection zone.
Sensor operates by itself. (Ghosting)	Waterdrops on the front cover	Install in a place keeping the waterdrops off.
The sensor functions without the front cover but not with it.	The module angle is changed. The front cover is dirty. The front cover is scratched	Check the module angles. Wipe the front cover with a damp cloth. (Do not use any cleaner or solvent.) Replace the front cover.
Sensor operation is not linked to door movement.	Connection error or wrong mounting side setting.	Check the wiring or mounting side setting. (Dipswitch B4)
Door remains open or closed without any object in the detection area.	Presence timer set to infinity and sudden change in the detection area. Signal saturation. (Slow Red blinking)	Push the function switch for less than 2 sec. for learning. Or change presence timer setting. (Dipswitch A4) Change the module positions or adjust angles or adjust the area width (Dipswitch B2).
	The sensor is affected by the floor color.	Push the function switch for less than 2 sec. for learning. Or extend the non detection zone.
	Communication error. (Twice Orange blinking)	Check the communication wires.
	The front cover on inner or outer side is dirty.	Wipe the front cover with a damp cloth. (Do not use any cleaner or solvent.)
	Sensor failure. (Fast Red blinking)	Contact your installer or service engineer.

Manufacturer

OPTEX CO.,LTD.

5-8-12 Ogoto Otsu 520-0101, Japan
TEL.: +81(0)77 579 8700 FAX.: +81(0)77 579 7030
WEBSITE: www.optex.co.jp

European Subsidiary

OPTEX Technologies B.V.

Tiber 2, 2491 DH The Hague, The Netherlands
TEL.: +31(0)70 419 41 00 FAX.: +31(0)70 317 73 21
E-MAIL: info@optex.nl WEBSITE: www.optex.nl